

Receiver

From

Society
Reference
Address
Phone
Fax
E-mail

Item n° :

60112985

Model :

VA 65/180

Pump data

Pressure rating : 10 bar (1000 KPa)

Min. fluid temperature : -10 °C

Max. fluid temperature : 110 °C

Minimum suction head :

Temperature °C

Minimum suction head : m

Requested data

Flow :

Head :

Fluid (%) :

Fluid Temperature : 20 °C

Density : 998,3 kg/m³

Kinematic viscosity : 1,005 mm²/s

Vapor pressure :

Hydraulic data (duty point)

Flow :

Head :

Materials

Pump body	Cast iron
Impeller	Technopolymer
Motor shaft	Stainless steel
Air vent plug	Brass
Seal ring	Etylene propylene
Motor casing	Die cast aluminium
Stator jacket	Stainless steel

Curve tolerance according to ISO 9906

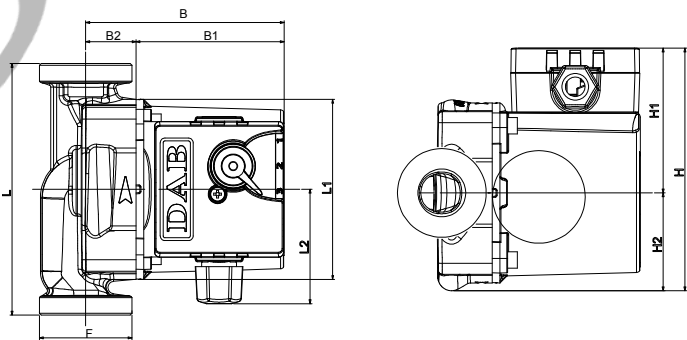
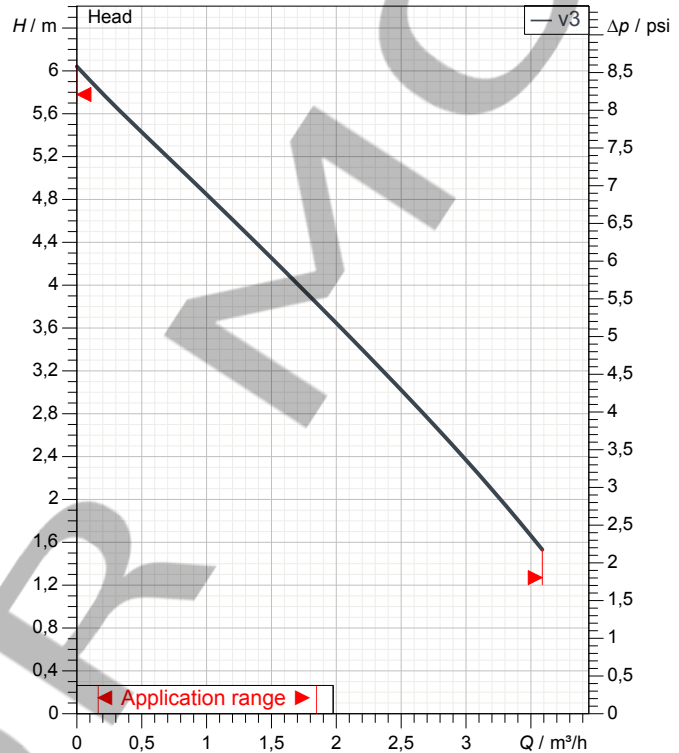

Motor data

Motor brand : DAB

Power input P1 : 0,078 kW

Rated speed : 2310 1/min

Rated voltage : 1~ 230 V 50 Hz

Nominal current : 0,34 A

Degree of protection : IP 44

Dimensions in mm

B	104	H1	75				
B1	78	H2	49				
B2	26	L	180				
F	1" 1/2	L1	98				
H	124	L2	60				

Weight : 2,6 kg

Pump connection

Suction side : 1" 1/2 G / 10 bar (1000 KPa)

Discharge side : 1" 1/2 G / 10 bar (1000 KPa)

Receiver

From

Society
Reference
Address
Phone
Fax
E-mail

VA 65/180

Curve tolerance according to ISO 9906

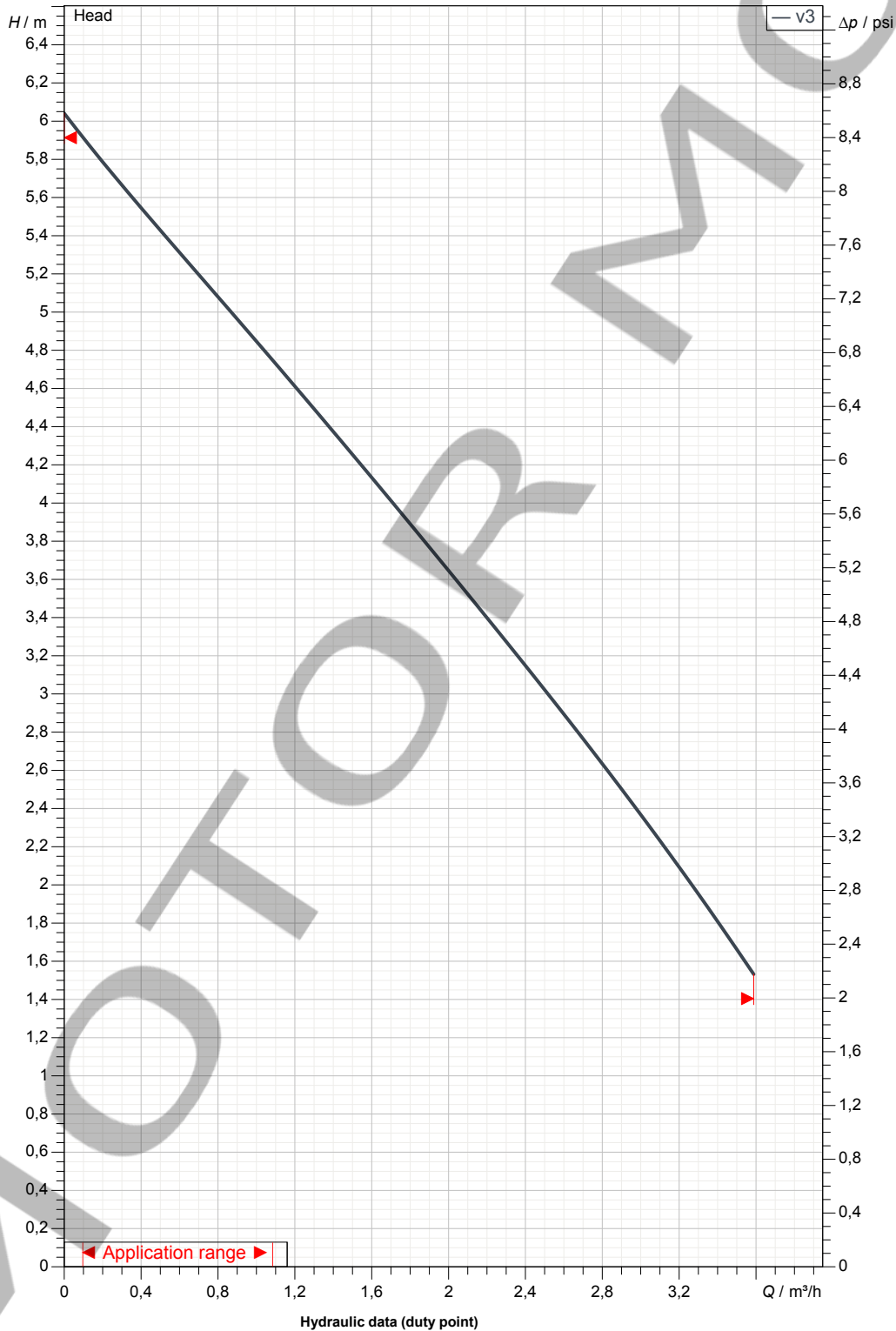

Suction side :
1" 1/2 G
10 bar (1000 KPa)

Discharge side :
1" 1/2 G
10 bar (1000 KPa)

Flow :

Head :

Rated speed :
2310 1/min

MAIN_PROJECT_TITLE

BUSINESS_PROCESS_IC

OWNER_

ISSUE_DATE



DIMENSIONAL DRAWING

DAB PUMPS S.p.A.
Via Marco Polo, 14 - 35035 Mestrino (PD), Italy
Tel. +39 049 5125000 - Fax +39 049 5125950
www.dabpumps.com

30/07/2015

Page 3 / 3

Receiver

From

Society
Reference
Address
Phone
Fax
E-mail

VA 65/180

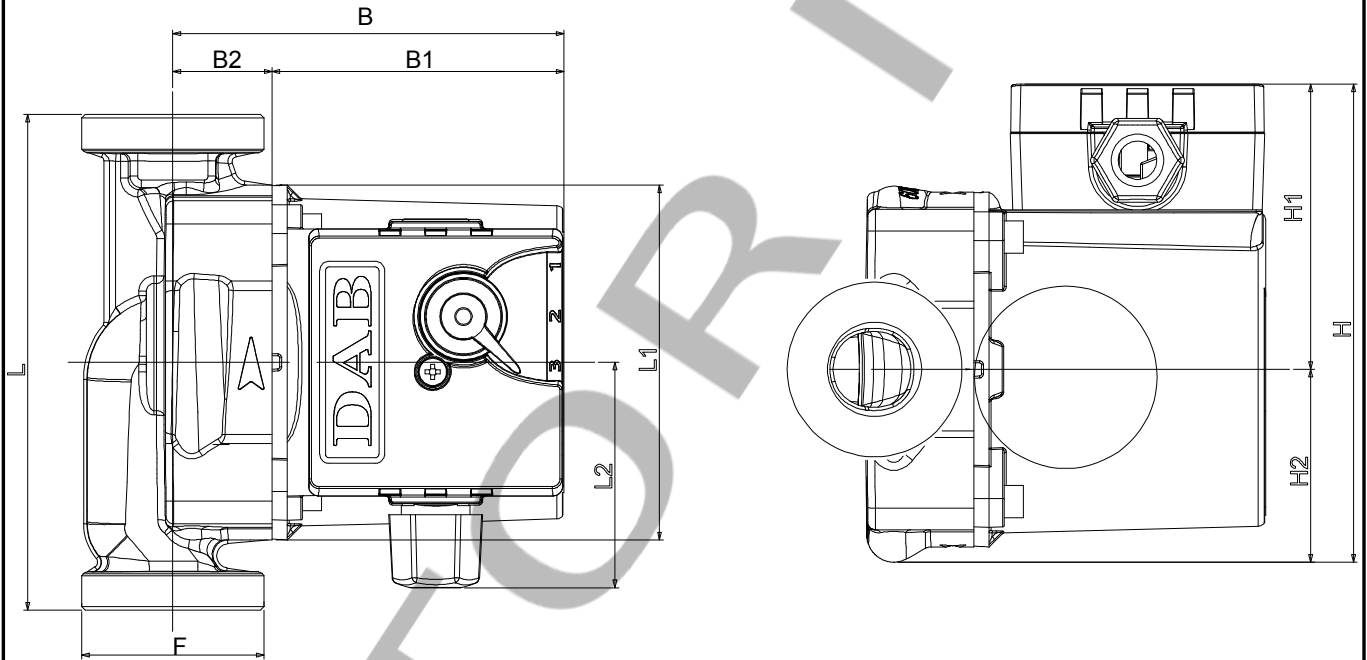

Dimensions in mm

1	B	104
2	B1	78
3	B2	26
4	F	1" 1/2
5	H	124
6	H1	75
7	H2	49
8	L	180
9	L1	98
10	L2	60

Pump connection

Suction
1" 1/2 G
10 bar (1000 KPa)

Discharge
1" 1/2 G
10 bar (1000 KPa)

MAIN_PROJECT_TITLE

BUSINESS_PROCESS_ID

OWNER

ISSUE_DATE