

Contar Descripción

1 HYDRO MPC-E 5 CRE45-1-1



Adverta! la foto puede diferir del actual producto



Código: 99166959

Pressure booster system supplied as compact assembly according to DIN standard 1988/T5.

All pumps are speed-controlled.

From 0.37 to 11 kW, the booster system is equipped with CR, CRE, CRI, CRIE pumps with commutated permanent-magnet motors with extremely high efficiency. The total efficiency including the frequency converter applies to IE5 level in IEC60034-31.



From 15 to 22 kW, the booster system is equipped with CR, CRE, CRI, CRIE pumps with motors with integrated frequency control. The total efficiency of the motor including the frequency converter is better than the IE3 level in IEC60034-31, even though this standard only applies to the motor.

- * Hydro MPC-E maintains a constant pressure through continuous adjustment of the speed of the pumps.
- * The system performance is adapted to the demand through cutting in/out the required number of pumps and through parallel control of the pumps in operation.
- * Pump changeover is automatic and depends on load, time and fault.

The system consists of these parts:

- * Pump parts in contact with the pumped liquid are made of stainless steel EN DIN 1.4301
- * Pump bases and heads are of either cast iron/stainless steel (CRI) or cast iron EN-GJS-500-7 (CR), depending on pump type; other vital parts are made of stainless steel EN DIN 1.4301
- * The pumps are equipped with a service-friendly cartridge shaft seal, HQQE (SiC/SiC/EPDM)
- * Two stainless steel manifolds to EN DIN 1.4571
- * Stainless steel base frame to EN DIN 1.4301 up to CR 64. Above CR 64 the pumps are placed on a galvanized C-profile frame
- * One non-return valve (POM) and two isolating valves for each pump
- * Non-return valves are certified according to DVGW, isolating valves according to DIN and DVGW
- * Adapter with isolating valve for connection of diaphragm tank
- * Pressure gauge and pressure transmitter (analog output 4-20 mA)
- * Control MPC in a steel cabinet, IP54, including main switch, all required fuses, motor protection, switching equipment and microprocessor-controlled CU 352.

Dry-running protection and diaphragm tank are available according to the list of accessories.

Pump operation is controlled by Control MPC with the following functions:

- * Intelligent multipump controller, CU 352.
 - Constant-pressure control through continuously variable adjustment of the speed of each individual pump.
 - PID controller with adjustable PI parameters (Kp + Ti).
 - Constant pressure at setpoint, independent of inlet pressure.
 - Soft pressure build-up (To prevent water hammer during startup).
 - On/off operation at low flow.
 - Automatic cascade control of pumps for optimum efficiency.
 - Selection of min. time between start/stop, automatic pump changeover and pump priority.
 - Automatic pump test function to prevent idle pumps from seizing up.
 - Possibility of standby pump allocation.
 - Possibility of backup sensor (redundant primary sensor).
 - Secondary sensor (Possible to switch to another sensor/setpoint).
 - Multi-sensor (up to 6 sensors to influence the setpoint).
 - Manual operation.

Contar	Descripción
--------	-------------

Possibility of external setpoint influence.
 Log function.
 Setpoint ramp.
 Possibility of digital remote-control functions:
 System on/off.
 Max., min. or user-defined duty.
 Up to 6 alternative setpoints.
 Digital inputs and outputs can be configured individually.
 Pump and system monitoring functions:
 Minimum and maximum limits of current value.
 Inlet pressure.
 Non-return valve monitoring.
 Motor protection.
 Sensors and cables monitored for malfunction.
 Alarm log with the previous 24 warnings/alarms.
 Display and indication functions:
 Colour screen display.
 Green indicator light for operating indications and red indicator light for fault indications
 Potential-free changeover contacts for operation and fault.
 Grundfos bus communication.

It is possible to add CIM communication modules for communicating with Scada/BMS.

Pumps, piping, cabling complete as well as Control MPC are mounted on the base frame. The booster system has been preset and tested.

Fluido:	Agua
Presión max. del sistema:	16 bar
Caudal (Instalación):	350 m ³ /h
Alimentación:	380-415 V
Corriente nominal instalación:	49,8A-400V
Potencia nominal:	5.5 kW
Peso neto:	789 kg

Maximum head: 31 m
 Maximum flow: 350 m³/h

99166959 HYDRO MPC-E 5 CRE45-1-1 50 Hz

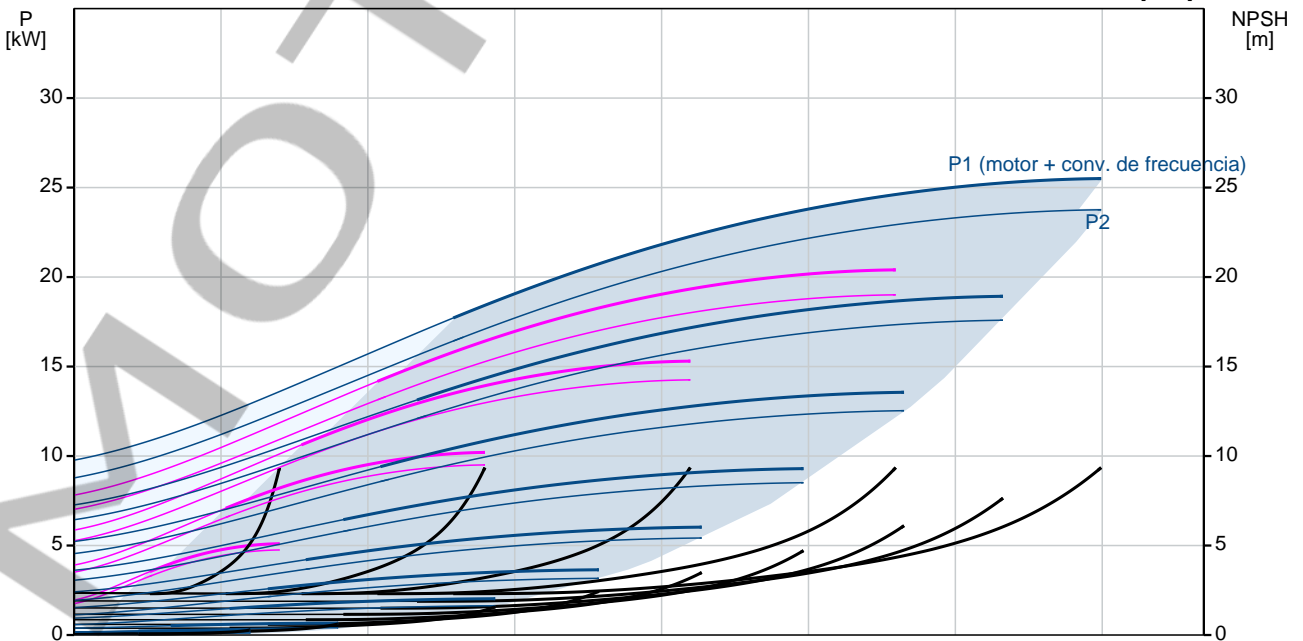
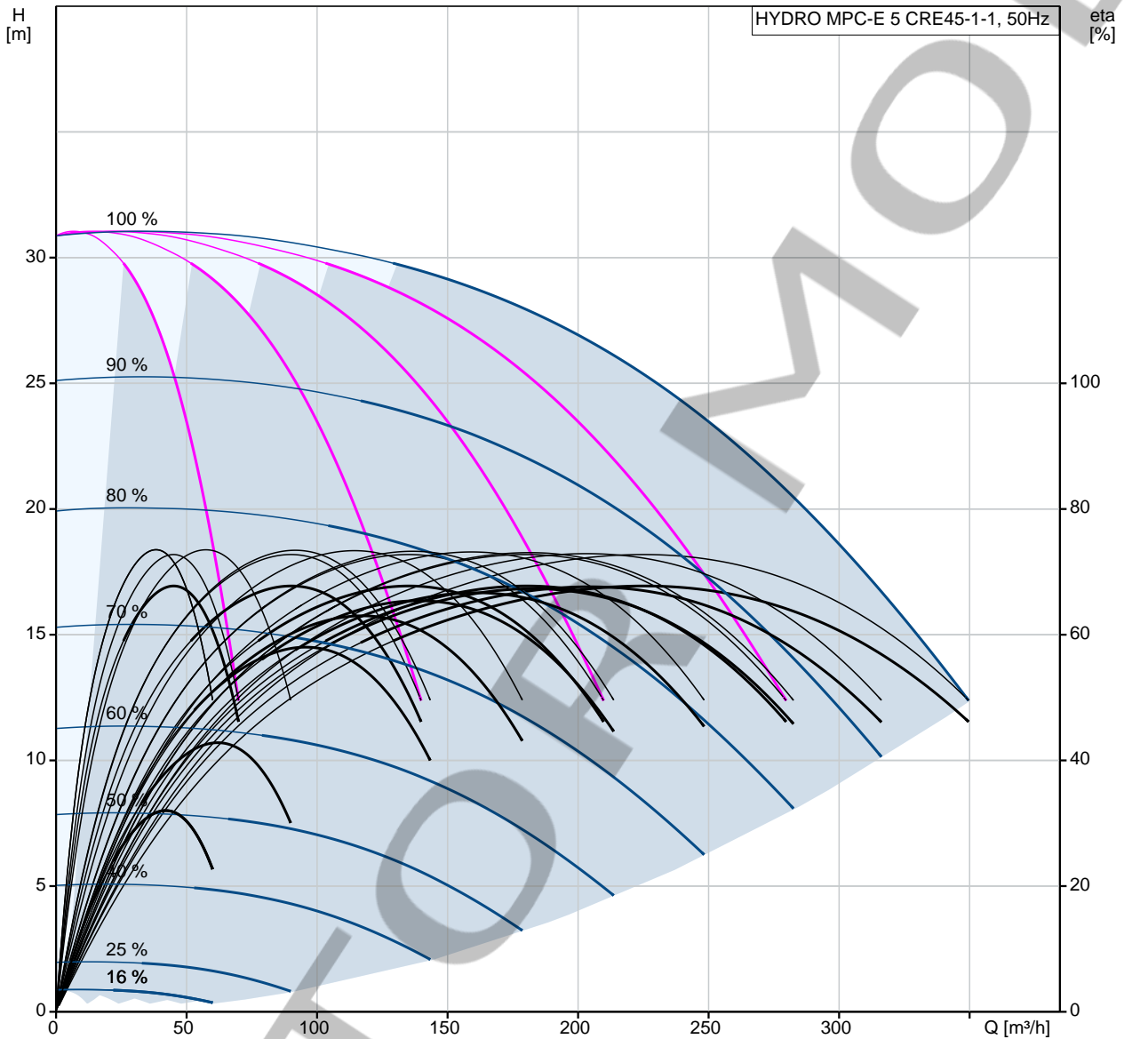

Descripción	Valor
-------------	-------

Información general:

Producto:: HYDRO MPC-E 5 CRE45-1-1
 Código:: 99166959
 Número EAN:: 5712607972813

Técnico:

Caudal nominal: 270 m³/h
 Caudal máx.: 350 m³/h
 Altura nominal: 22.1 m
 Altura máx.: 31 m
 Nombre de la bomba principal: CRE45-1-1
 Bomba princ. n.º: 99072009
 Número de bombas: 5

Materiales:

Colectores: EN/DIN 1.4571/ AISI 316 TI

Instalación:

Presión de trabajo máxima: 16 bar
 Entrada de colector: DN200
 Salida de colector: DN200
 Presión nominal: PN16
 Toma de tierra: PE
 Diseño del sistema: D

Líquido:

Líquido bombeado: Agua
 Rango de temperatura del líquido: 5 .. 60 °C
 Temperatura del líquido durante el funcionamiento: 20 °C
 Densidad: 998.2 kg/m³

Datos eléctricos:

Potencia (P2) bomba principal: 5.5 kW
 Frecuencia de red: 50 Hz
 Tensión nominal: 3 x 380-415 V
 Intensidad nominal del sistema: 49,8A-400V
 Tipo de arranque: electrónicoam.
 Grado de protección (IEC 34-5): IP54
 Supresión de radiointerferencias: EMC DIRECTIVE(2014/30/EU)

Paneles control:

Control type: E
 Dry running protection, mechanical: NONE

Otros:

Peso neto: 789 kg
 Peso bruto: 869 kg
 Gama de productos: Internacional
 Fichero de configuración Control MPC: 98271949

Fichero de configuración Hydro MPC: 98272018
 País de origen.: DE
 Tarifa personalizada n.º: 84137075

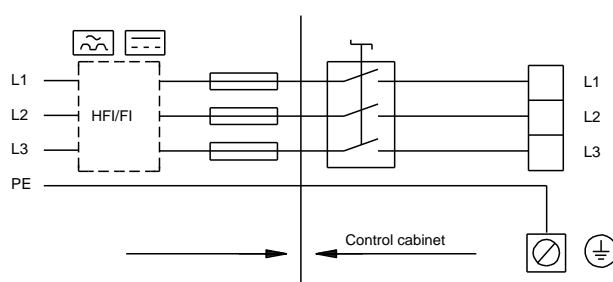
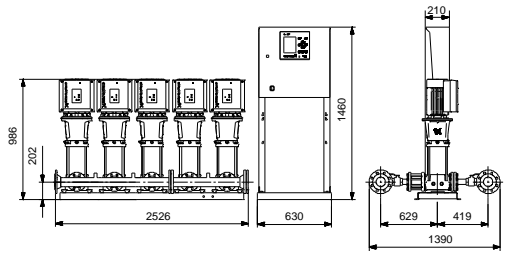
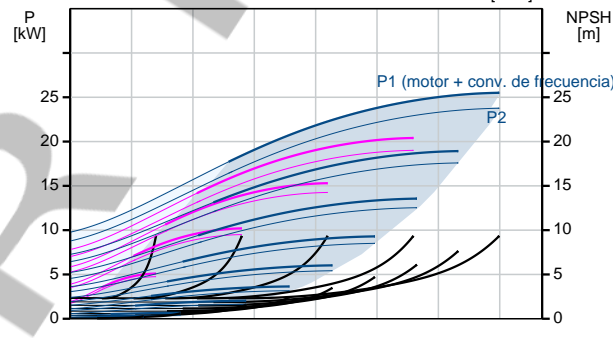
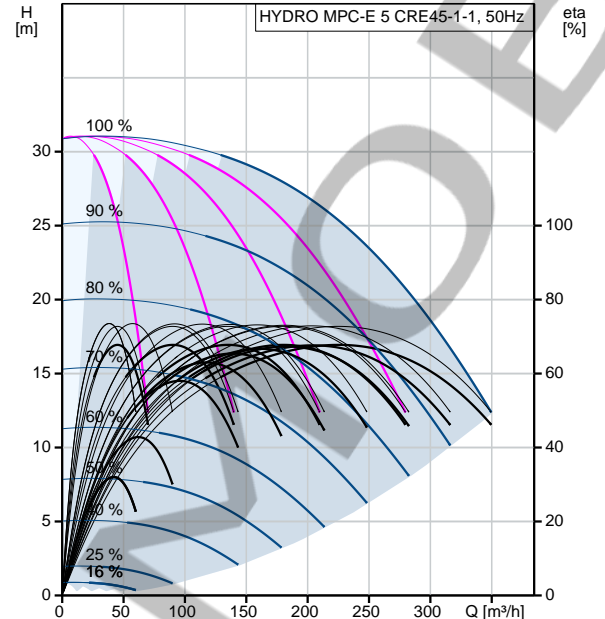

99166959 HYDRO MPC-E 5 CRE45-1-1 50 Hz

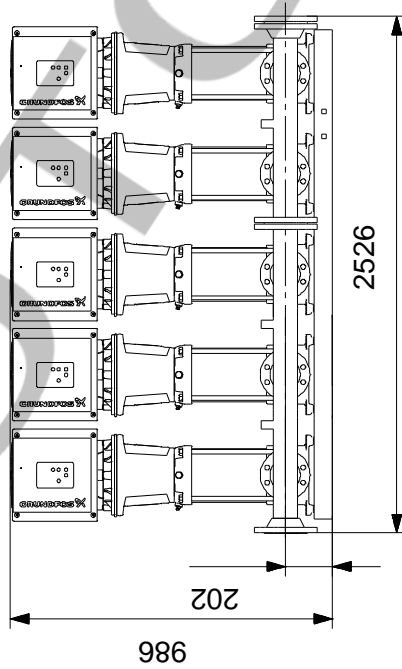
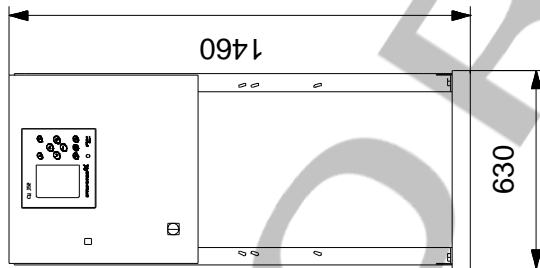
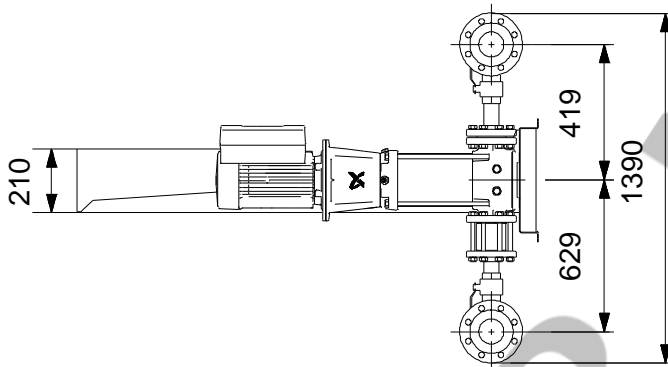

Nota: Todas las unidades están en [mm] a menos que se indiquen otras. Exención de responsabilidad: este esquema dimensional simplificado no muestra todos los detalles.

99166959 HYDRO MPC-E 5 CRE45-1-1 50 Hz

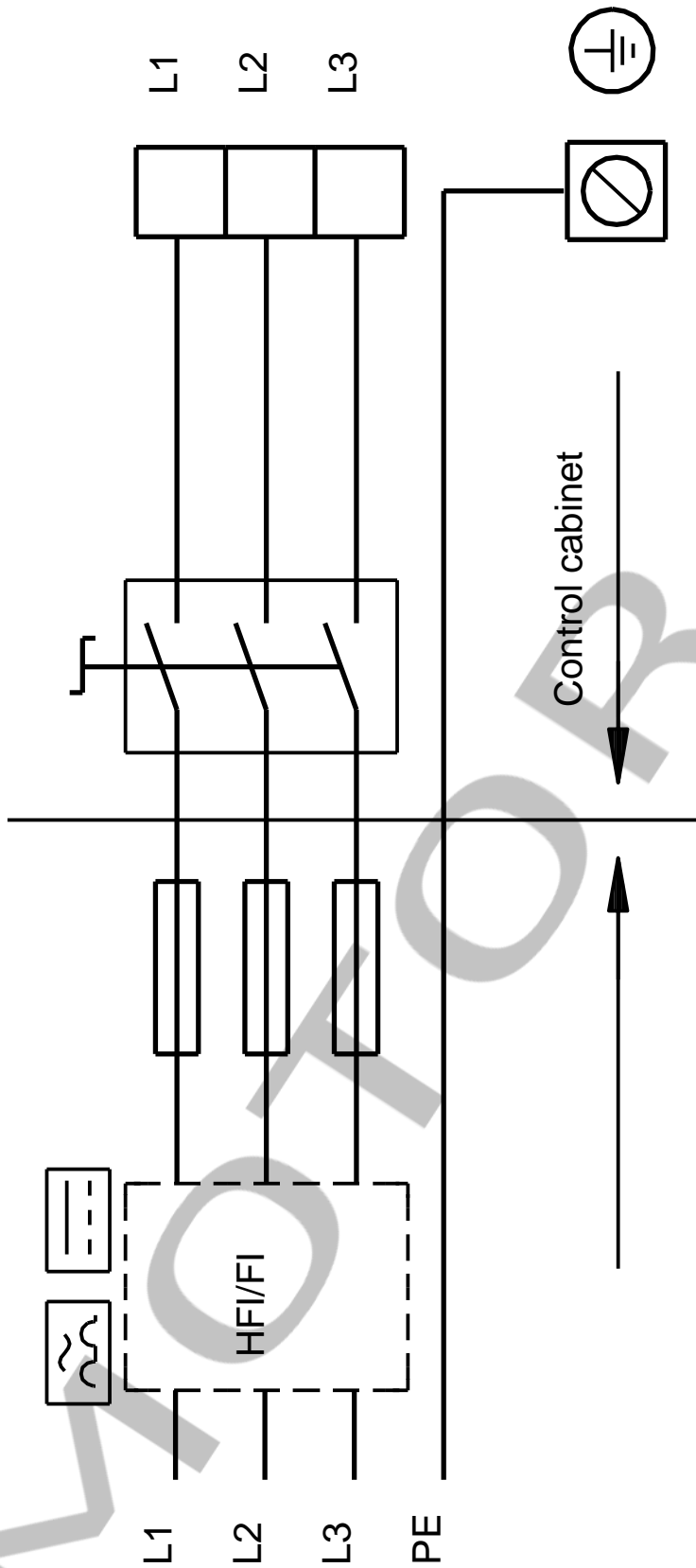

¡Nota! Uds en [mm] a menos que otras estén expresadas