

Contar Descripción

1 HYDRO MPC-E 6 CR64-3



Advierta! la foto puede diferir del actual producto

Código: [96941447](#)

Pressure booster system supplied as compact assembly according to DIN standard 1988/T5. All pumps are speed-controlled.

The booster system is equipped with CR pumps connected to external Grundfos CUE frequency converters (one per pump).

- * Hydro MPC-E maintains a constant pressure through continuous adjustment of the speed of the pumps.
- * The system performance is adapted to the demand through cutting in/out the required number of pumps and through parallel control of the pumps in operation.
- * Pump changeover is automatic and depends on load, time and fault.
- * All pumps in operation will run at individual speeds.

The system consists of these parts:

- * Pump parts in contact with the pumped liquid are made of stainless steel EN DIN 1.4301.
- * Pump bases and heads are of cast iron EN-GJS-500-7 (CR), other vital parts are made of stainless steel EN DIN 1.4301.
- * The pumps are equipped with a service-friendly cartridge shaft seal, HQQE (SiC/SiC/EPDM).
- * Two manifolds of stainless steel EN DIN 1.4571.
- * Base frame of stainless steel EN DIN 1.4301 up to CR 64. Above CR 64 the pumps are placed on a galvanized C-profile frame.
- * One non-return valve (POM) and two isolating valves for each pump.
- * Non-return valves are certified according to DVGW, isolating valves according to DIN and DVGW.
- * Adapter with isolating valve for connection of diaphragm tank.
- * Pressure gauge and pressure transmitter (analog output 4-20 mA).
- * Control MPC in a steel cabinet, IP 54, including main switch, all required fuses, motor protection, switching equipment and microprocessor-controlled CU 352.

Dry-running protection and diaphragm tank are available according to the list of accessories.

Pump operation is controlled by Control MPC with the following functions:

- * Intelligent multipump controller, CU 352.
- Constant-pressure control through continuously variable adjustment of the speed of each individual pump.
- PID controller with adjustable PI parameters (Kp + Ti).
- Constant pressure at setpoint, independent of inlet pressure.
- Soft pressure build-up (To prevent water hammer during startup).
- On/off operation at low flow.
- Automatic cascade control of pumps for optimum efficiency.
- Selection of min. time between start/stop, automatic pump changeover and pump priority.
- Automatic pump test function to prevent idle pumps from seizing up.
- Possibility of standby pump allocation.
- Possibility of backup sensor (redundant primary sensor).
- Secondary sensor (Possible to switch to another sensor/setpoint).
- Multi-sensor (up to 6 sensors to influence the setpoint).
- Manual operation.
- Possibility of external setpoint influence.
- Log function.
- Setpoint ramp.
- Possibility of digital remote-control functions:



Contar	Descripción
--------	-------------

System on/off.
 Max., min. or user-defined duty.
 Up to 6 alternative setpoints.
 Digital inputs and outputs can be configured individually.
 Pump and system monitoring functions:
 Minimum and maximum limits of current value.
 Inlet pressure.
 Motor protection.
 Sensors and cables monitored for malfunction.
 Alarm log with the previous 24 warnings/alarms.
 Display and indication functions:
 Colour screen display.
 Green indicator light for operating indications and red indicator light for fault indications.
 Potential-free changeover contacts for operation and fault.
 Grundfos bus communication.

It is possible to add CIM communication modules for communicating with Scada/BMS.

Fluido:	Agua
Presión max. del sistema:	16 bar
Caudal (Instalación):	612 m³/h
Alimentación:	380-415 V
Corriente nominal instalación:	330,6A-400V
Potencia nominal:	30 kW
Peso neto:	2920 kg

Maximum head: 131 m
 Maximum flow: 612 m³/h

96941447 HYDRO MPC-E 6 CR64-3 50 Hz

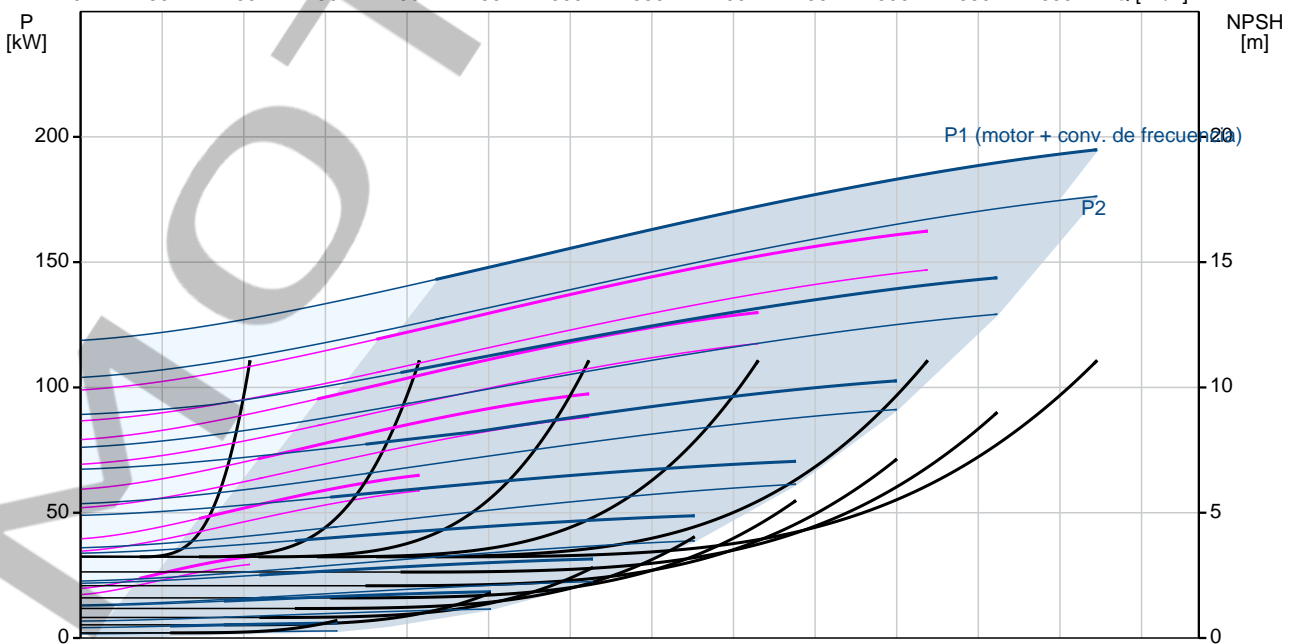
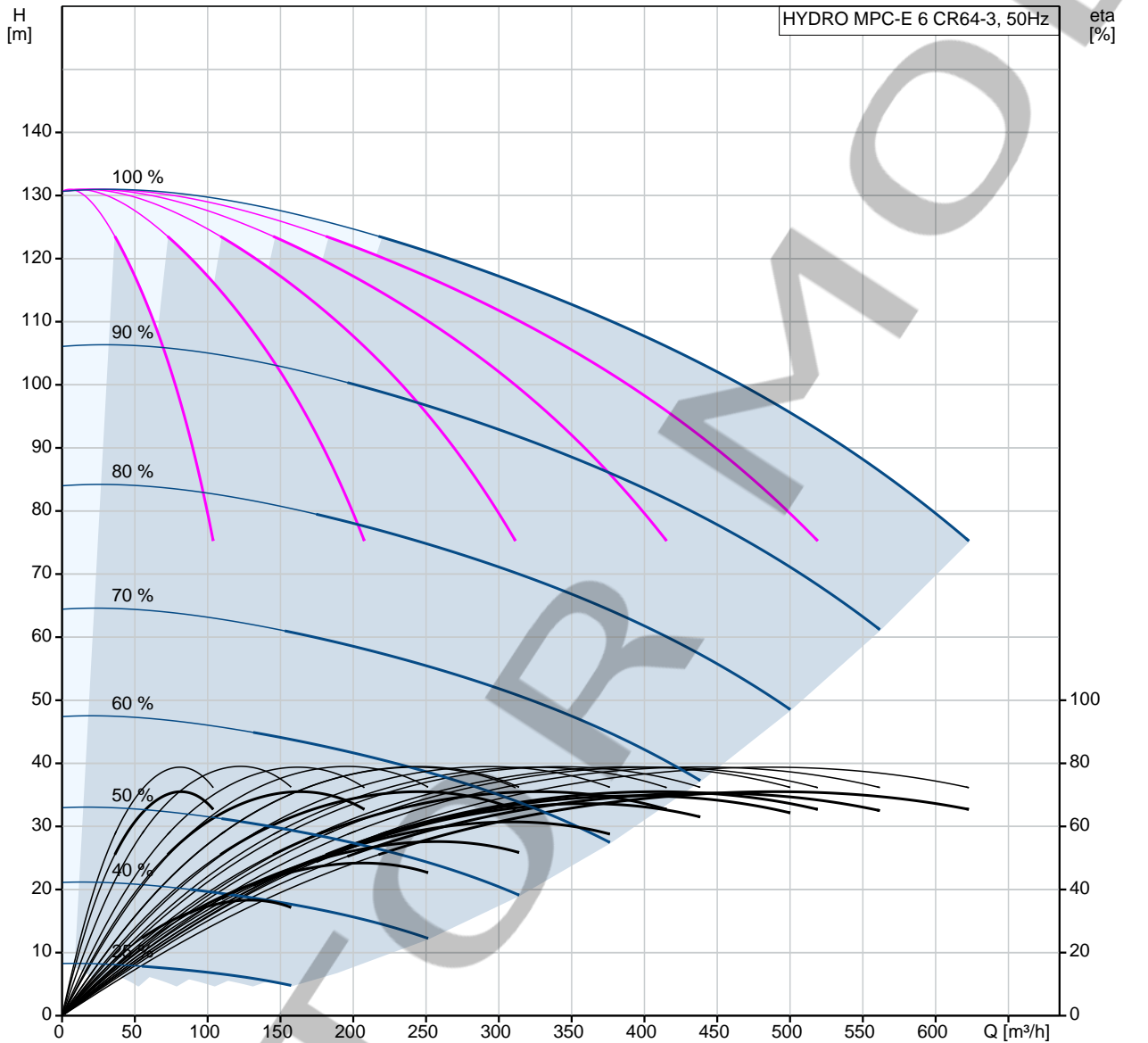

Descripción	Valor
-------------	-------

Información general:

Producto:: HYDRO MPC-E 6 CR64-3
 Código:: [96941447](#)
 Número EAN:: 5700314239770

Técnico:

Caudal nominal: 462 m³/h
 Caudal máx.: 612 m³/h
 Altura nominal: 98.9 m
 Altura máx.: 131 m
 Nombre de la bomba principal: CR64-3
 Bomba princ. n.º: 96123689
 Número de bombas: 6
 Válvula antirret.: lado descarga

Materiales:

Colectores: EN/DIN 1.4571/ AISI 316 TI

Instalación:

Presión de trabajo máxima: 16 bar
 Presión de entrada máxima permitida: 2.9 bar
 Entrada de colector: DN200
 Salida de colector: DN200
 Presión nominal: PN16
 Toma de tierra: PE
 Diseño del sistema: C

Líquido:

Líquido bombeado: Agua
 Rango de temperatura del líquido: 5 .. 60 °C
 Temperatura del líquido durante el funcionamiento: 20 °C

Densidad: 998.2 kg/m³

Datos eléctricos:

Potencia (P2) bomba principal: 30 kW
 Frecuencia de red: 50 Hz
 Tensión nominal: 3 x 380-415 V
 Intensidad nominal del sistema: 330,6A-400V
 Tipo de arranque: S/D
 Grado de protección (IEC 34-5): IP54
 Supresión de radiointerferencias: EMC DIRECTIVE(2014/30/EU)

Paneles control:

Control type: E
 Dry running protection, mechanical: NONE

Depósito:

Depósito de membrana: No

Otros:

Peso neto: 2920 kg
 Peso bruto: 3060 kg
 Gama de productos: Internacional
 Fichero de configuración Control MPC: 98271950
 Fichero de configuración Hydro MPC: 98272018
 País de origen.: DE
 Tarifa personalizada n.º: 84137075

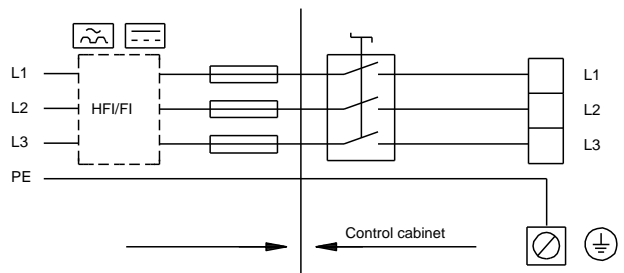
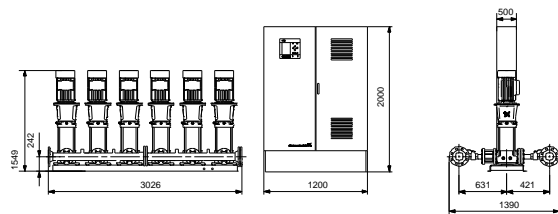
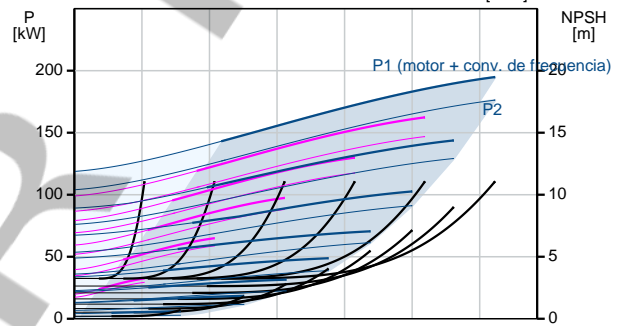
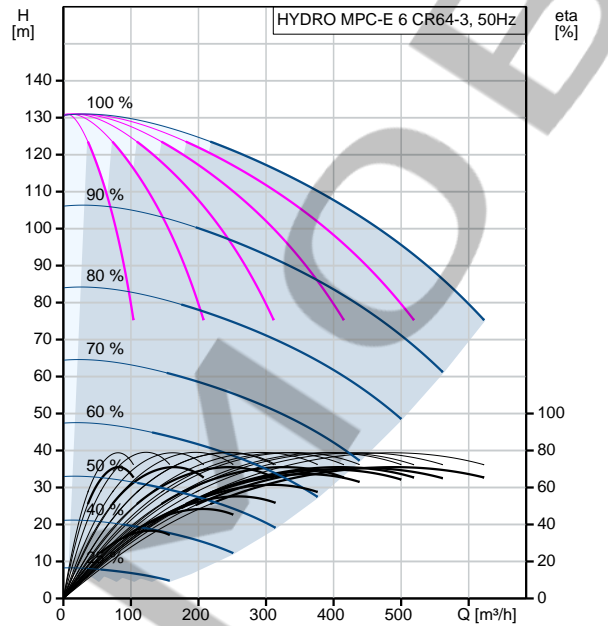

96941447 HYDRO MPC-E 6 CR64-3 50 Hz

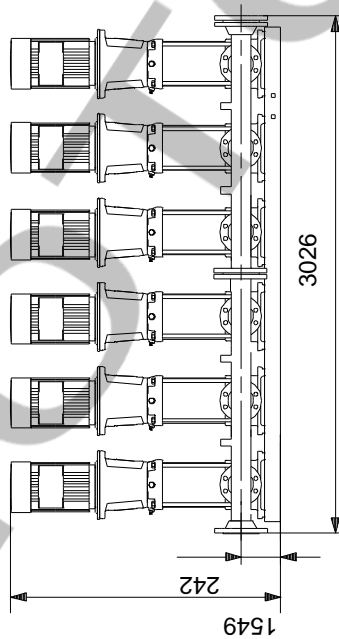
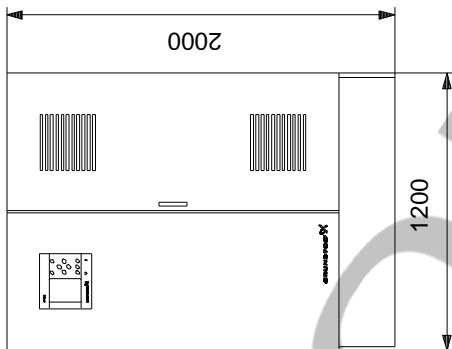
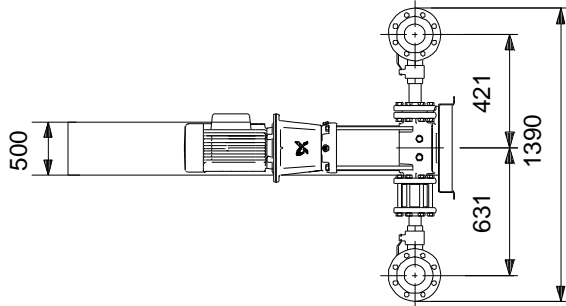

Nota: Todas las unidades están en [mm] a menos que se indiquen otras. Exención de responsabilidad: este esquema dimensional simplificado no muestra todos los detalles.

96941447 HYDRO MPC-E 6 CR64-3 50 Hz

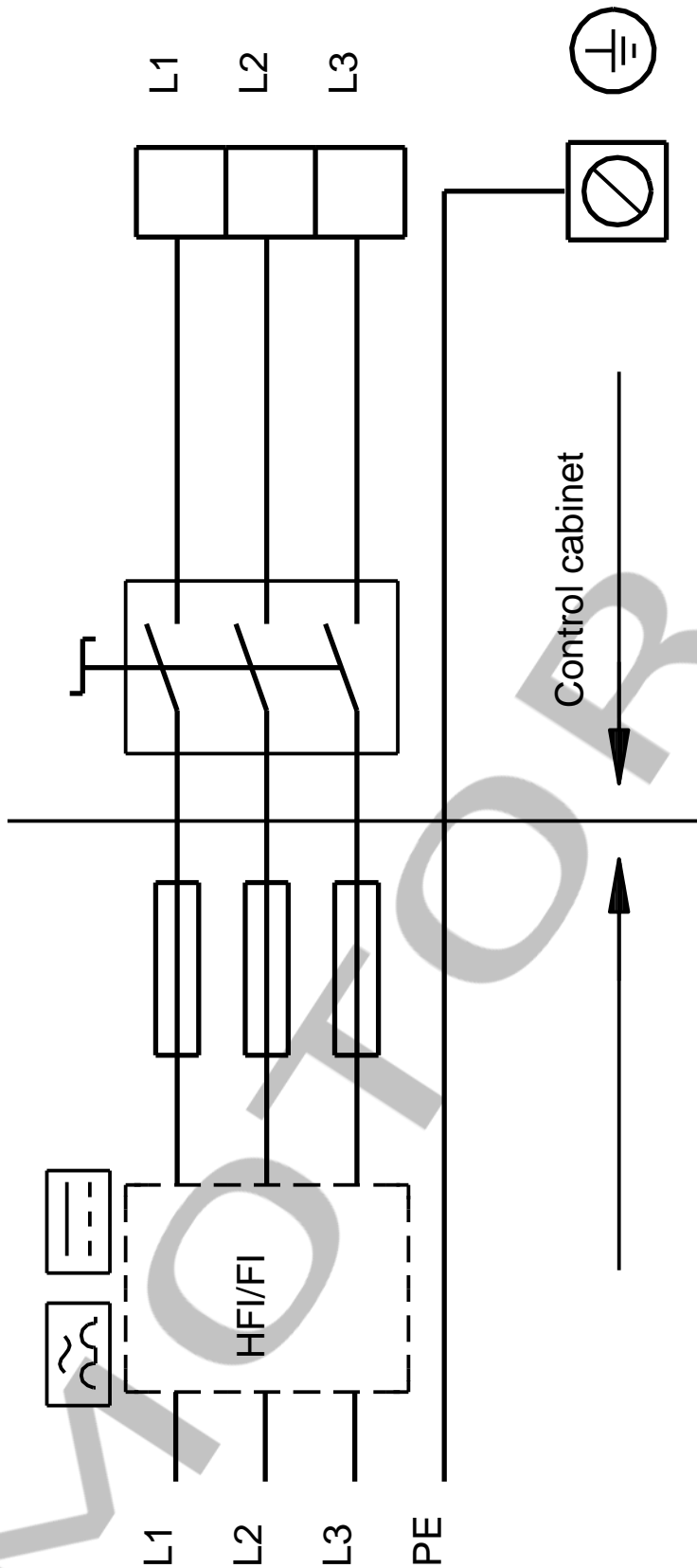

¡Nota! Uds en [mm] a menos que otras estén expresadas